

# QUANTUM® 2.0

UNLOCK YOUR POTENTIAL

## QUANTUM® SPLIT ARROW BOARD

QT1020H



**Specifications** ▲  
pp. 03

**Wiring Guide** ▲  
pp.03

**Patterns & Modes** ▲  
pp.04

**Quick Setup Guide** ▲  
pp.05

**Fenix University** ▲  
pp.06



**Fenix Product Copyrights** This price list and the mentioned Fenix products include or describe copyrighted Fenix material. Laws in the United States and other countries preserve for Fenix Industries and its licensors certain exclusive rights for copyrighted material, including the exclusive right to copy, reproduce in any form, distribute and make derivative works of the copyrighted material. Accordingly, any copyrighted material of Fenix and its licensors contained herein or in the Fenix products described in this Price List may not be copied, reproduced, distributed, merged or modified, transmitted, transcribed, stored in retrieval system or translated into any language or computer language, in any form or by any means, without prior written permission of Fenix Industries, Inc.. Fenix and the stylized Fenix logo are registered in the U.S. Patent & Trademark Office.



# SAFETY REGULATIONS & WARRANTY

## Safety Regulations

The following provides all the information necessary to safely operate the previously listed products of Feniex Industries, Inc. Please read this manual thoroughly before installing or operating your new product in order to prevent any damage or injury. Failure to follow the listed instructions in this manual may result in damage to your products or personal injury.

- Proper installation of this product requires good knowledge of automotive systems, electronics and procedures.
- Please guarantee all vital components of the vehicle are not in danger of being damaged by drilling holes necessary for installation. Check all sides of the mounting surface before drilling any holes into the vehicle.
- Do not install this product in any way that interferes with the deployment of the air bag. Doing so may damage the effectiveness of the air bag and can lead to serious personal and vehicle injury. The installer will assume full responsibility of proper installation of the new unit.
- Please clean the mounting surface before installation of the unit when using tape, brackets, magnet, Velcro or suction cups.
- The product's ground wire must be connected directly to the Negative (-) battery post for effective use of the unit. Please follow all wiring guidelines provided to guarantee long lifespan and productivity. Failing to follow these instructions may result in damage to the product.

## Warranty

Feniex Industries, Inc. warrants to the original purchaser that all our products shall be free from defects in material and workmanship. Feniex Industries' speakers, sirens, rocker panels, AM600 Beacons, Torch Lights, AI lightbars, AI Cubes, AM900 Work Lights, 8.5" Dome Lights, Cargo Lights, flashlights, Remote Spot Lights, and controllers are warranted for 2 years from the manufacturing date. In addition, all other products are warranted for 5 years from the manufacturing date.

If a warranty problem occurs, please contact customer support at 1.800.615.8350 or visit the website at [www.feniex.com/support](http://www.feniex.com/support).

If the product needs to be returned for repair or replacement, call our customer support line to receive a return merchandise authorization number.

Operational times are from 9 a.m. to 6 p.m. central time, Monday through Friday. Please do not send in product without contacting support first for an RMA number.

## Service After Expiration

Feniex Industries will still provide service for all products after the expiration of the warranty. In some instances it may be necessary for the product to be shipped, freight prepaid, and insured for loss or damage to Feniex headquarters.

**Warning!** Utilizing non-factory screws and mounting brackets may result in loss of warranty coverage.

## Copyright

This instruction manual and the Feniex products described in this instruction manual may include or describe copyrighted Feniex material. Laws in the United States and other countries preserve for Feniex Industries and its licensors certain exclusive rights for copyrighted material, including the exclusive right to copy, reproduce in any form, distribute, and make derivative works of the copyrighted material. Accordingly, any copyrighted material of Feniex and its licensors contained herein or in the Feniex products described in this instruction manual may not be copied, reproduced, distributed, merged, or modified in any manner without the express written permission of Feniex Industries, Inc.

## Feniex Product Copyrights

The products described in this document are the property of Feniex Industries, Inc. It is furnished by express license agreement only and may be used only in accordance with the terms of such an agreement. Products and documentation are copyrighted materials. Making unauthorized copies is prohibited by law. No part of the product or documentation may be reproduced, transmitted, transcribed, stored in a retrieval system, or translated into any language or computer language, in any form or by any means, without prior permission from Feniex Industries, Inc.



## BOX CONTENTS

1x - Quantum Split Arrow Board

1x - 2-pin USB Connector\*

1x - Mounting Hardware Kit

\*These items come attached to the product.

## WIRE HARNESS



15ft. 10 input wire harness with 2 serial wires (white & green)

## WIRING GUIDE

WIRE	INPUT
Red	12V+
Black	Ground
White	USB Port A
Green	USB Port B
Blue	12V+, Input 1
Orange	12V+, Input 2
Brown	12V+, Input 3
Gray	12V+, Input 4
Yellow	12V+, Input 5
Violet	12V+, Input 6
Blue/White	12V+, Input 7
Orange/White	12V+, Input 8
Brown/White	12V+, Input 9
Green/White	12V+, Input 10

## SPECIFICATIONS

**DIMENSIONS** 21.5" x 2.75" x 15"

**WARRANTY** 5 Years

**VOLTAGE** 10-18VDC

**CURRENT** 6 Amps @ 13V

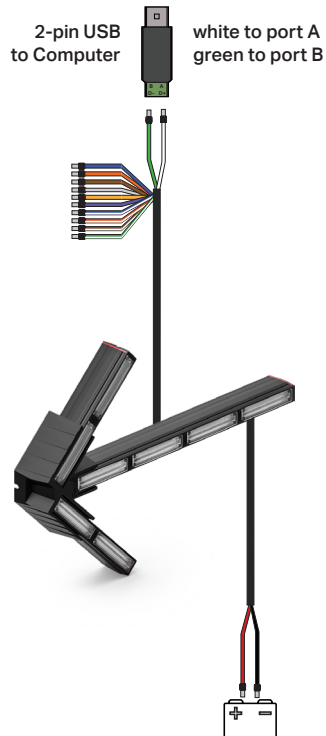



## **PATTERNS**

1	Attack	8	One-One Single	15	Figure 8 Chase
2	Cluster	9	One-One Triple	16	Night Ride Crossover
3	Cluster Mix	10	Two-Two Single	17	Hale Storm
4	Combo Single	11	Two-Two Triple	18	Pulse
5	Combo Triple	12	All-On Single	19	I/O Flux
6	Half-Half Single	13	All-On Triple	20	Spectrum
7	Half-Half Triple	14	Raging Beacon	21	Progressive Pursuit

## **FUNCTIONS**

1	Tail	6	Takedown
2	Cruise	7	Work Light
3	Flashing	8	Low Power
4	Turn Signal	9	Cut Off
5	Brake Signal	10	Pattern Change

## **INPUTS**

10	Hardwire Inputs
28	Inputs w/ Converter

## **BRIGHTNESS**

10%	100%
50%	Park Pattern



## ▲ QUICK SETUP GUIDE

### ■ 1. Unbox Quantum® Product

Remove the Quantum® product from its packaging. Locate the Quantum® product and the 2-pin USB drive:

2-pin USB  
Connector



### ■ 2. Download Quantum® Unlock Software

Visit website [http://unlock.feniex.com/site/change\\_log](http://unlock.feniex.com/site/change_log) or use the QR code to download the Quantum® unlock software.



### ■ 3. Install Quantum® Unlock Software

The Quantum® Unlock Software is available for both PC and Mac. The software will allow the user to completely configure their Quantum Products (i.e color, modes, functions).



### ■ 4. Connect Quantum® to your Computer

Open Quantum® Software. Connect the Quantum® product to your computer using the 2-pin USB connector.

2-pin USB to  
Computer



### ■ 5. Power the Quantum® Product

Connect the red wire to a 12v+ terminal and the black wire to Ground to power on your Quantum® product.

- ▶ white to port A
- ▶ green to port B

### ■ 6. Open Feniex University

Open Feniex University to follow step-by-step instructions on how to configure your Quantum product.





# FENIEX UNIVERSITY

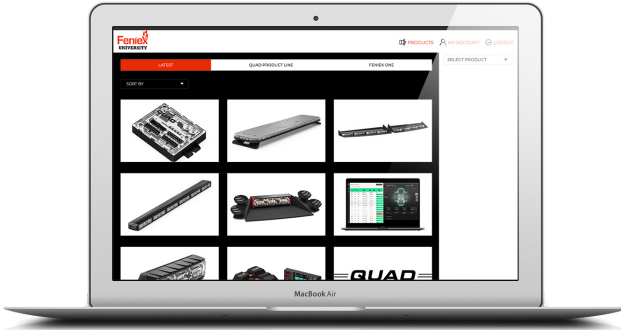

## ■ Feniex University

Before installing the Quantum product, watch our instructional video series; Feniex University. Get an in-depth look at how to program and install your products using the Quantum Unlock Software



### ■ Visit Feniex University

[feniex.com/university/](http://feniex.com/university/)



### ■ Download Quantum Unlock Software

[http://unlock.feniex.com/site/change\\_log](http://unlock.feniex.com/site/change_log)



## ▲ QUANTUM SOFTWARE

### ■ Unlocking Quantum

Every Quantum product is programmed to be a “Single” color platform from the factory. Single color implies one color LED per module as a “Single” color use. All 5 colors can be used on this platform as a single color or single function operation (i.e., if my single color lightbar has takedowns it is defaulted with a white colored module. I cannot change my takedowns as red, blue, or amber in color). Each function like STT, Alley, and Takedowns are defaulted to a specific-colored module. Users can unlock different levels through their unlock portal.

### ■ User Unlock with Hardware & User Interface

Users will have access to a Quantum user interface. This will allow the user to make any level changes to their product(s) and configure their product to their specific needs. A USB dongle will be provided for every Quantum product.

### ■ User Configuration with Hardware & User Interface

Every end user can make any configuration change based on their current unlock level. On single, dual, and tri level of purchase they have up to 60 days to make any necessary color changes to their product(s) before it locks in permanently. No color changes are available after 60 days.

### ■ Configuring Products

#### Levels:

- ▶ Single
- ▶ Dual
- ▶ Trio
- ▶ Quad
- ▶ Quint
- ▶ Amber

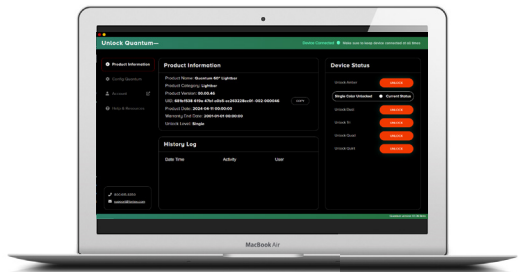



## ▲ SINGLE COLOR OPTIONS

The product can be in any color scheme utilizing all 5 colors on a single module and the use of all 5 options (i.e., takedown, alleys, and stop, turn, and tail). This configuration is the most widely used as a single-color platform by most agencies nationally and internationally. It covers the basics of police and fire color schemes widely known in our industry. In this illustration, this lightbar is fully populated with every possible Quantum function available and has more capabilities for a budget department than they need.

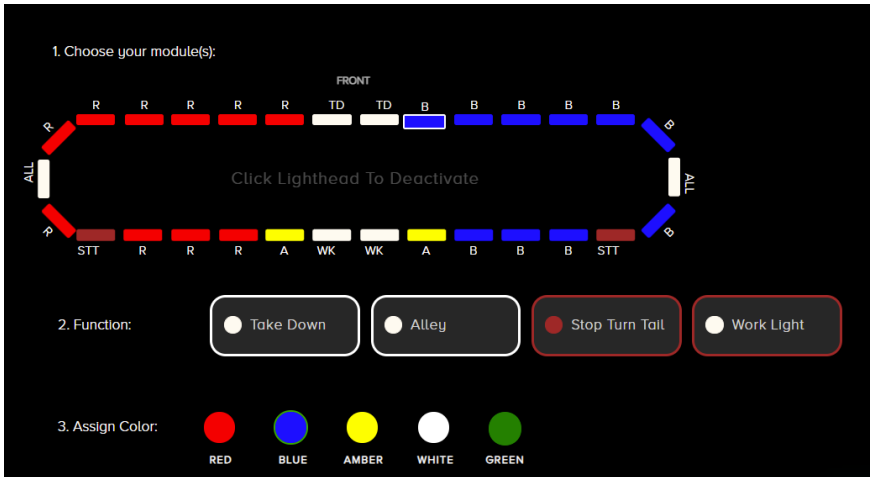

**Most common single-color configuration for Police, Fire & EMS:**  
*Driver red, passenger blue, takedowns, alleys, and STT [Stop, Turn, Tail]*





## DUAL COLOR OPTIONS

The standard driver red, passenger blue, with the addition of white to their emergency flash pattern, with flood takedowns and flood alleys (modular capability), full traditional amber directional, rear worklights and Stop, Turn, and Tail.

1. Choose your module(s):

2. Assign Color:

RED/BLUE	RED/WHITE	RED/AMBER	BLUE/WHITE	BLUE/AMBER
AMBER/WHITE	RED/GREEN	BLUE/GREEN	AMBER/GREEN	WHITE/GREEN

### Most common dual-color configurations for Police, Fire & EMS:

*Driver red, passenger blue, flood takedowns, flood alleys, amber arrows, STT, Worklights.*

A popular public safety build w/ every necessary function. While maintaining the traditional amber and blue, a flood 360 is a must for night work while adding the DOT approved lighting functions needed with stop, turn and tail.



## TRI COLOR OPTIONS

This color combo sets the bar for an enhanced traditional red and blue lightbar. It features an abundance of red and blue lights throughout the entire lightbar, complemented by all-white lights spanning 360 degrees. While the inclusion of all-white lights may seem excessive, they are necessary for optimal visibility. With our diverse flash patterns and a combination of reds, blues, and whites, the lightbar will undoubtedly stand out. Stop, turn, and tail functions are always optional. Compared to the predecessor standard build of driver red, passenger blue, and two takedowns, this setup provides coverage across a larger area in terms of color, surpassing what is typically needed.

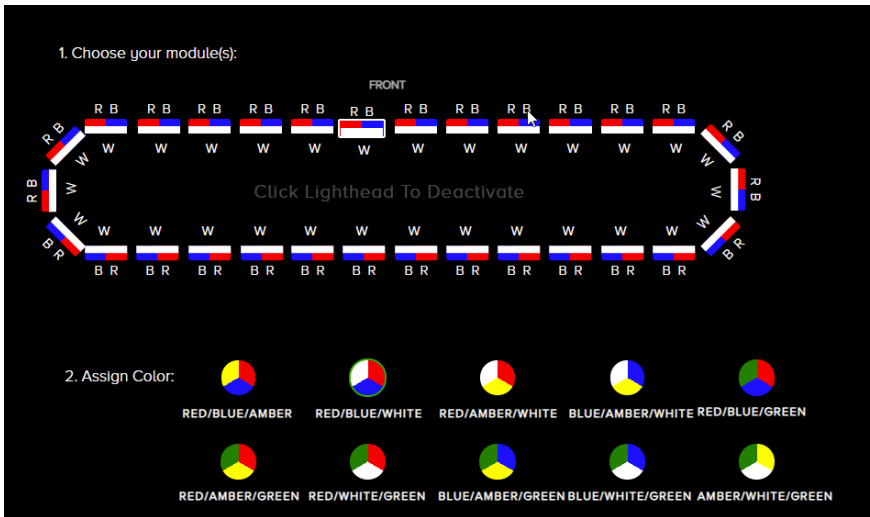

### Most common dual-color configurations for Police, Fire & EMS:

*Driver red, passenger blue, flood takedowns, flood alleys, amber arrows, STT, Worklights.*



## QUAD COLOR OPTIONS

Featuring a versatile combination of blue, red, white, and amber lights, this configuration offers a comprehensive array of colors suitable for various emergency and utility applications. The inclusion of blue and red lights ensures high visibility and compliance with emergency vehicle regulations, while white lights provide additional illumination for optimal visibility in all conditions. The amber lights may serve as directional indicators or provide warning signals, adding to the functionality and effectiveness of the lightbar in different scenarios.

1. Choose your module(s):

Click Lighthouse To Deactivate

2. Assign Color:

RED/BLUE/AMBER/WHITE	RED/BLUE/AMBER/GREEN	RED/BLUE/WHITE/GREEN
RED/AMBER/WHITE/GREEN	BLUE/AMBER/WHITE/GREEN	



## QUINT COLOR OPTIONS

Enjoy all five colors any time!



## AMBER COLOR OPTIONS

The most popular economical amber lightbar configuration. This setup encompasses one of the most common configurations in the amber market with Stop Turn Tail, Alleys, and Takedown. This along with Amber modules for warning/flash mode provides a popular and economical amber solution.

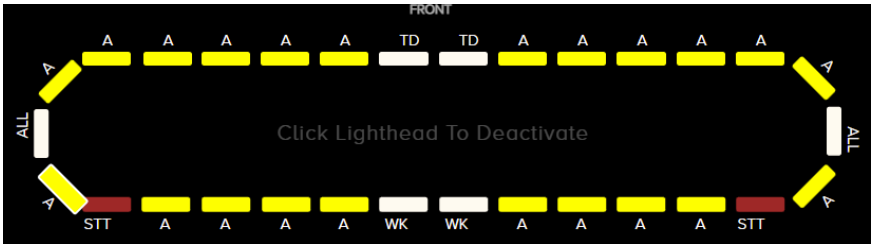

**Most common amber-color configuration for Public Safety with all available options:** *Driver red, passenger blue, takedowns, alleys, and STT [Stop, Turn, Tail]*



## ▲ FENIEX CONVERTER

Quantum programming unlocks more modes and functionality for your Quantum product. Quantum full-sized lightbars come with 13 programmable inputs and all other Quantum products (excluding mini lightbars), come with 10 programmable inputs. The Fenix Converter increases your modes to 28 inputs.

Follow the steps below to connect your product to the Fenix Converter.

### ■ Connecting Quantum® to the Fenix Converter

1. Connect your Quantum product to the Fenix Converter by using your data wires to the A and B inputs (Green wire to A, White wire to B).
2. Power your Quantum product by connecting the red wire to a 12V+ terminal and the black wire to Ground.
3. Power your Fenix Converter to a 12V battery by connecting the red wire to a 12V+ terminal and the black wire to Ground.
4. Use the provided Fenix Converter wiring harnesses to connect the wires to inputs 1-28.

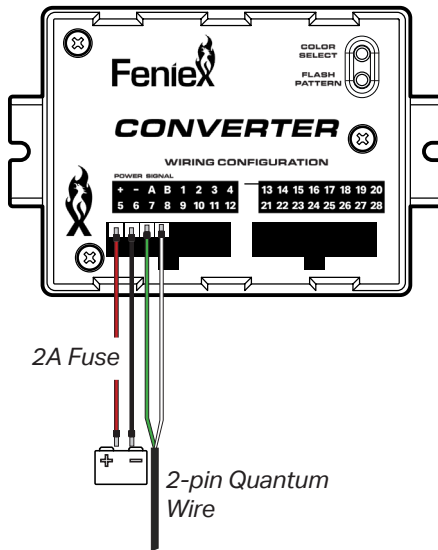

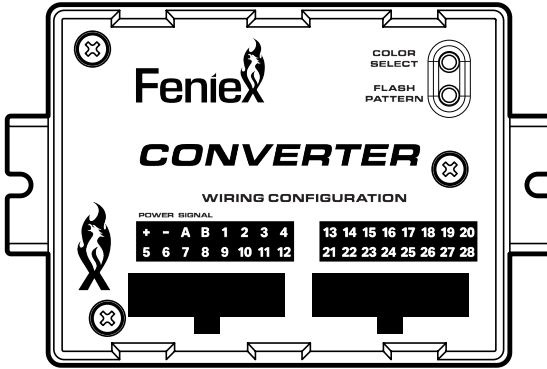

## CONVERTER INPUT GUIDE

1	Input 1	15	Input 15
2	Input 2	16	Input 16
3	Input 3	17	Input 17
4	Input 4	18	Input 18
5	Input 5	19	Input 19
6	Input 6	20	Input 20
7	Input 7	21	Input 21
8	Input 8	22	Input 22
9	Input 9	23	Input 23
10	Input 10	24	Input 24
11	Input 11	25	Input 25
12	Input 12	26	Input 26
13	Input 13	27	Input 27
14	Input 14	28	Input 28



## PROGRAMMING FENIEX CONVERTER [CONT.]

### Improved Quantum Functions

Fenix Converter for all Quantum products is now programmable. There are up to 28 programmable inputs of your choice. They can have an infinite number of flash patterns, 28 different alley light configurations, 28 variable arrow functions, etc.

► *All programming will be done through the end-user app when configuring.*

### Understand the Fenix Converter

Each input shown in the illustration below is a direct correlation with the inputs on the Fenix Converter. The end-user is required to map out their specific configurations to a 12V+, triggering a controller like the 4200 Data Link, Mini 4200, Typhoon, Fenix One (analog 12V+ triggers).

*Example of User Interface:*

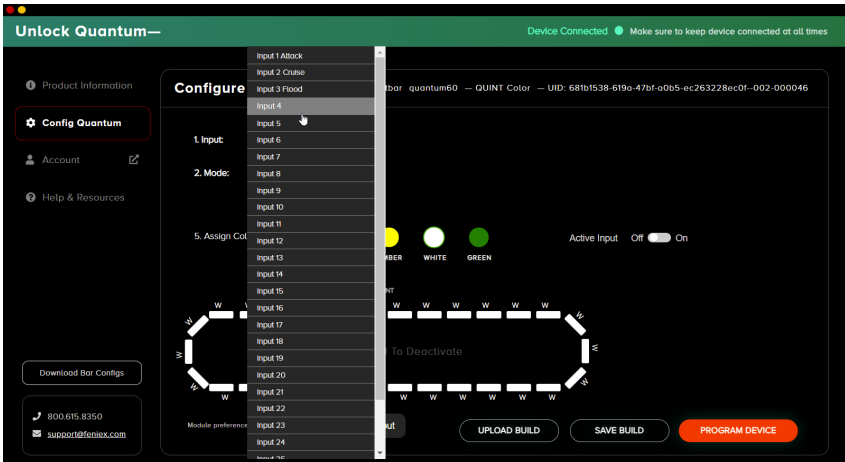



## PAYMENT

Purchasing and upgrading your Quantum products is easy. Start by connecting your Quantum product to your computer and opening your Quantum Unlock Software and clicking "Account."

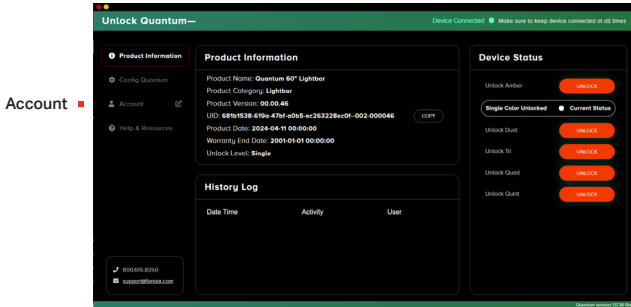

You will be redirected to another screen for payment information. Add a Payment Method by selecting "Add a New Card."

### ■ Pay to Unlock

Unlock Once added, select "Pay to Unlock" to upgrade your Quantum products.

### ■ Payment History

To view past purchases with Quantum, select "Purchase History" in the right side menu.

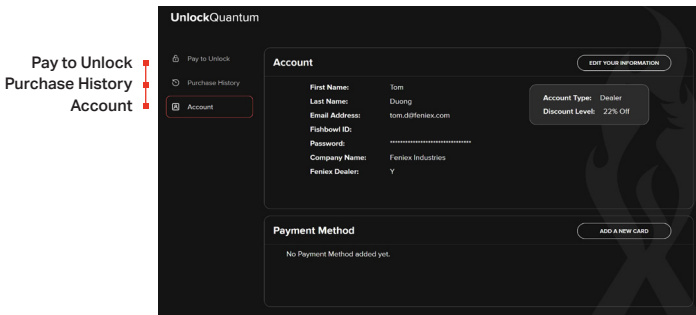





## ▲ PAYMENT (DEALER ACCESSIBILITY)

The dealer can setup their own account on a provided web link that is accessible through their inside sales representative.

